

# ΤΟ ΚΛΕΙΔΙ ΤΟΥ ΣΟΛ

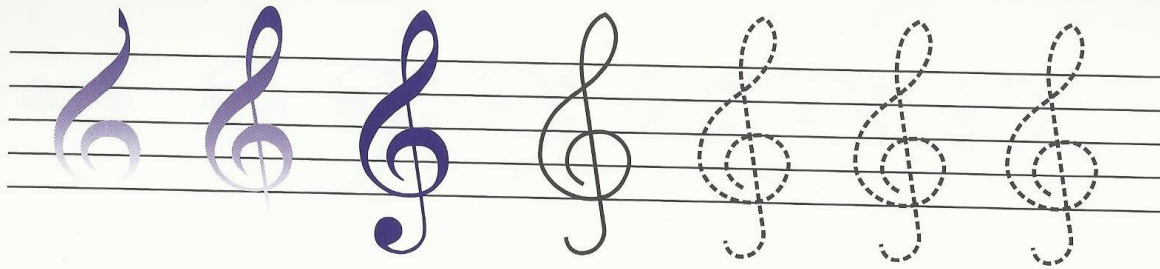

Προσπάθησε κι εσύ να σχεδιάσεις το κλειδί του ΣΟΛ

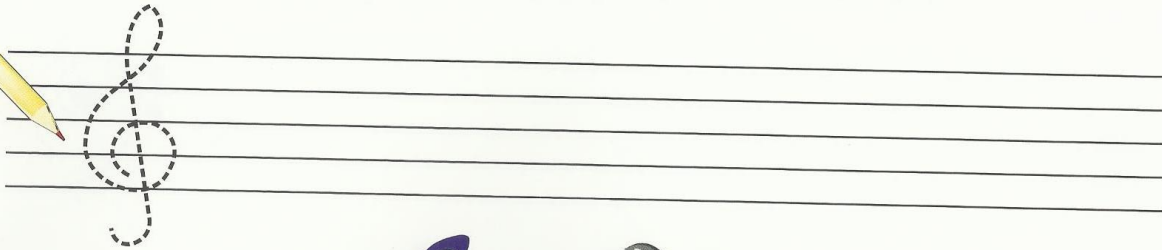

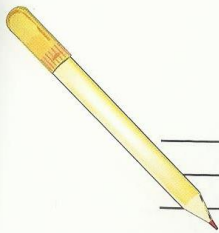

# HÄNSCHEN KLEIN

Γερμανικό λαϊκό τραγούδι



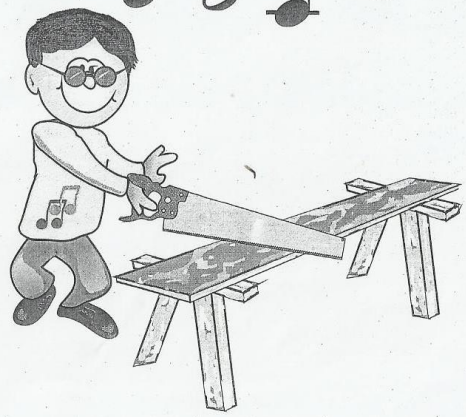

Μπορείς να χωρίσεις τη μελωδία σε μέτρα;

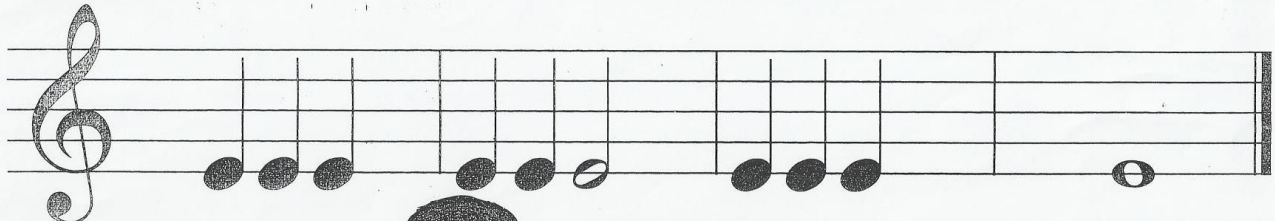
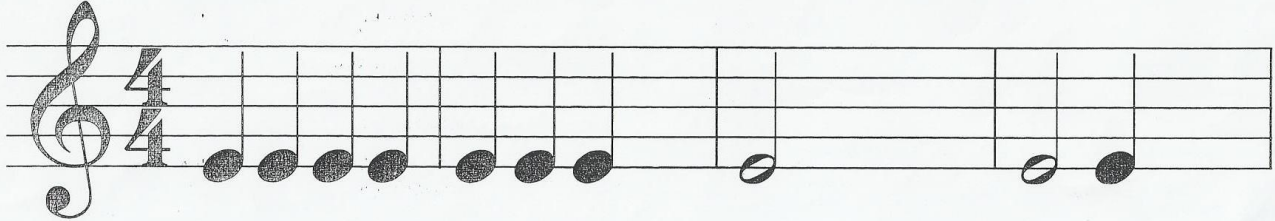

# ΣΥΜΠΛΗΡΩΣΕ ΤΑ ΜΕΤΡΑ

Συμπλήρωσε τα μέτρα με τις αξίες που λείπουν.



ΝΟΤΑ	ΠΑΥΣΗ	ΝΟΤΑ	ΠΑΥΣΗ	ΝΟΤΑ	ΠΑΥΣΗ	ΝΟΤΑ	ΠΑΥΣΗ
							

Μπορείς να γράψεις παύσεις ίσης αξίας με τις νότες που υπάρχουν στα τετραγώνια;

Μπορείς να γράψεις νότες ίσης αξίας με τις παύσεις που υπάρχουν στα τετραγώνια;

ΠΑΥΣΗ	ΝΟΤΑ	ΠΑΥΣΗ	ΝΟΤΑ	ΠΑΥΣΗ	ΝΟΤΑ	ΠΑΥΣΗ	ΝΟΤΑ
							

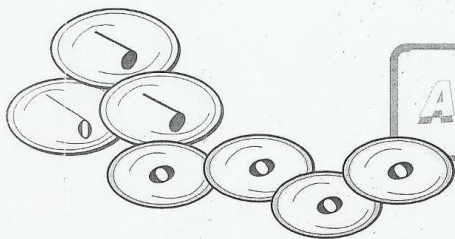

# ΑΝΤΙΣΤΟΙΧΕΣ ΑΞΙΕΣ

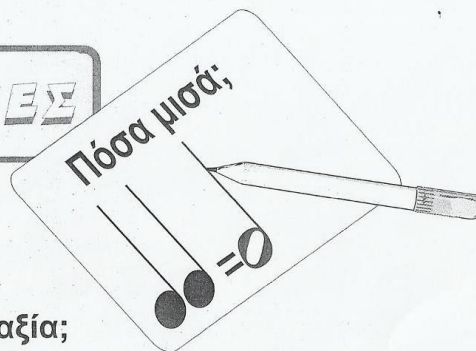

Μπορείς να γράψεις νότες με ίση αξία;

Πόσα τέταρτα;



Πόσα τέταρτα;



Πόσα μισά;



Πόσα ολόκληρα;

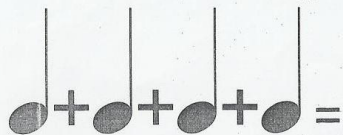

Πόσα μισά;

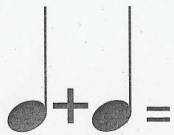

Πόσα ολόκληρα;



Πόσα τέταρτα;

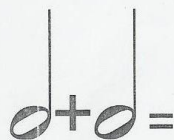

Πόσα ολόκληρα;

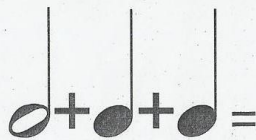

Πόσα μισά;

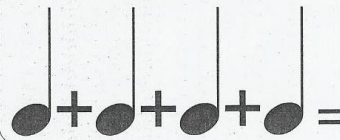

# ΣΩΣΤΟ - ΛΑΘΟΣ

Βρες το λάθος και χρωμάτισέ το με κόκκινο.  
Βρες το σωστό και χρωμάτισέ το με πράσινο.

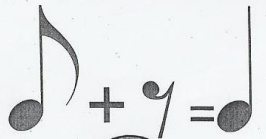

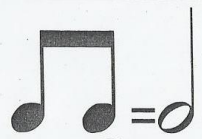

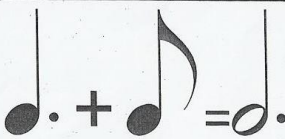

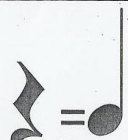

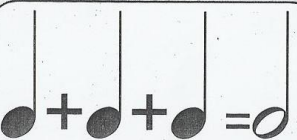

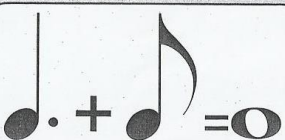

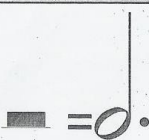

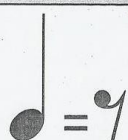

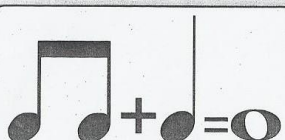

# ΧΡΩΜΑΤΙΣΕ

Χρωμάτισε με κίτρινο χρώμα τα δύο πνευστά όργανα.  
Μπορείς με τη βοήθεια του κωδικού να γράψεις τα ονόματά τους  
και σε ποιά ομάδα πνευστών ανήκουν;

### ΚΩΔΙΚΟΣ

↑	♯	■	◻	✕	∟	ζ	♪	✈	◎	♭	
Τ	Ρ	Ν	Μ	Κ	Ε	Α	Π	Ι	Χ	Λ	Ο

↑ ♯ ♭ ■ ζ ✕ ↑ ∟

---

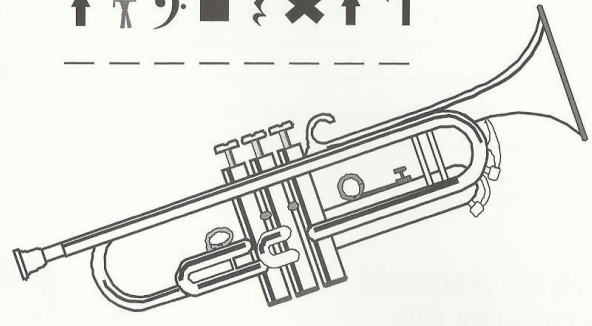

↑ ♯ ♭ ■ ζ ♭ ♯ ♪

---

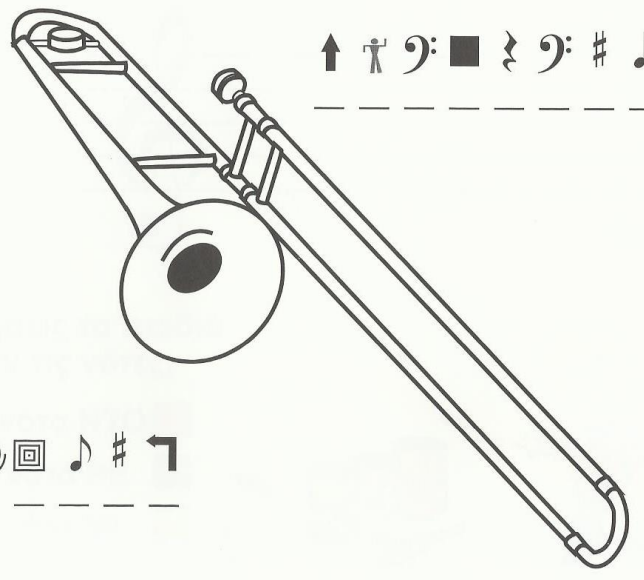

✈ ∟ ◎ ◻ ♪ ♯ ∟

---